

# Technical data sheet

90° bend 160 FT

Item number: 6098734



90° bend, horizontal, for all wide span cable trays of 160 mm side height.  
For further stabilisation, additional supports should be planned for the area of the fittings.



**St** Steel

**FT** Hot-dip galvanised

## Master data

Item number	6098734
Type	WRB 90 163 FT
Description 1	90° bend
Description 2	for wide span cable tray 160
Manufacturer	OBO
Dimension	160x300
Material	Steel
Surface	Hot-dip galvanised
Surface standard	DIN EN ISO 1461
Smallest sales unit	1
Unit of quantity	Piece
Weight	1751 kg
Weight unit	kg/100 pc.

## Dimensions

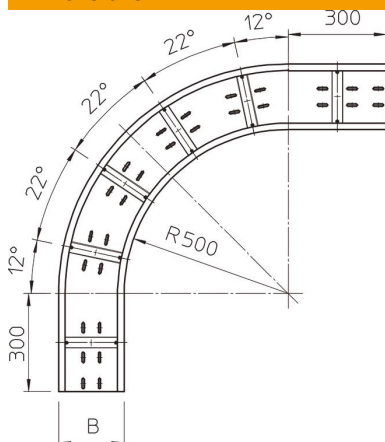

Width	300 mm
Height	160 mm
Plate thickness	2 mm
Dimension B	300 mm
Dimension R	500 mm

# Technical data sheet

90° bend 160 FT

Item number: 6098734



## Technical data

Bend (angle)	90°
Connector version	Without connectors
Mounting perforation in base	yes
NATO hole pattern	no
Change of direction	Horizontal
Rustproof steel, pickled	no
Side perforation	no
Wide-span version	yes
Type of connector, cable support system	Screwed