

Technical data sheet

Box cover

Item number: 2003256

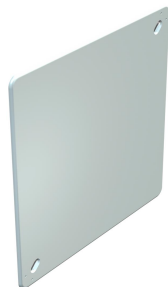

Box cover suitable for the connection sockets, type UV...K, cover edge is flush, surface is roughened, cover bolts can be lowered.



PS Polystyrene

Master data

Item number	2003256
Type	UV 250 D
Description 1	Box lid
Description 2	concealed
Manufacturer	OBO
Dimension	260x260x2,5
Colour	White
Material	Polystyrene
Smallest sales unit	5
Unit of quantity	Piece
Weight	17.19 kg
Weight unit	kg/100 pc.

Technical data sheet

Box cover

Item number: 2003256



Dimensions

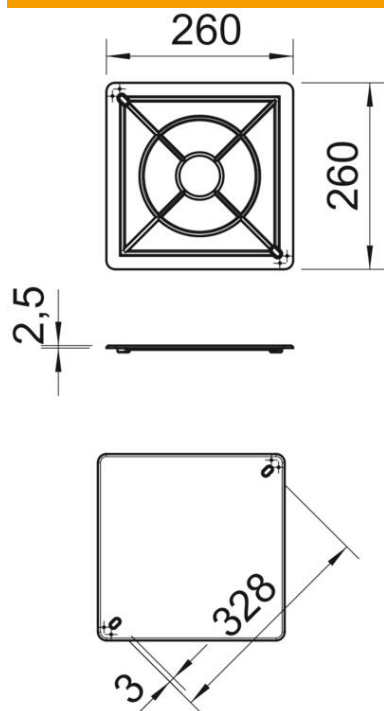

Length	260 mm
Width	260 mm
Height	2.5 mm
Dimension A	328 mm
Dimension B	260 mm
Dimension s	2.5 mm

Technical data

Fastening type	Screw-on lid
Flame-resistant	acc. to VDE 0471/DIN 695 Part 2-1, test temperature 650°C
Shape	Square
Halogen-free	yes
With bolts	no
Sealable	yes