

Technical data sheet

Pipe sleeve with 12 fastening straps

Item number: 7202216



Pipe sleeve for combustible pipes.

If there is a fire, fire protection inserts inside the sheet steel housing expand, exerting a very great pressure onto the burning thermoplastic pipes. For interior application. Fastening with anchors or M8 threaded rods.

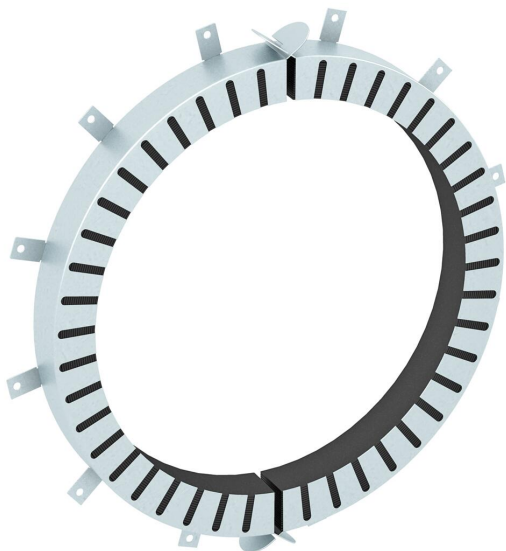

CE

Intumescent material

FS Strip galvanized

Master data

Item number	7202216
Type	TCX-280
Description 1	Pipe sleeve
Description 2	for combustible pipes
Manufacturer	OBO
Dimension	Ø280mm
Material	Intumescent material
Surface	Strip galvanized
Surface standard	DIN EN 10346
Smallest sales unit	1
Unit of quantity	Piece
Weight	398 kg
Weight unit	kg/100 pc.

Technical data sheet

Pipe sleeve with 12 fastening straps

Item number: 7202216



Dimensions

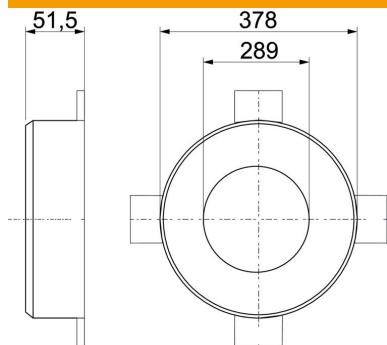

Length	378 mm
Width	378 mm
Height	51.5 mm
Dimension d	289 mm
Dimension d min.	378 mm
Dimension h	51.5 mm

Technical data

Shape	Round
For pipe diameter, max.	282 mm
For pipe diameter, min.	280 mm
Collar lock	Connector
With fastening material	no
Accessories required	yes