

# Technical data sheet

## Cable ladder with Z rung, standard A4

Item number: 7098228

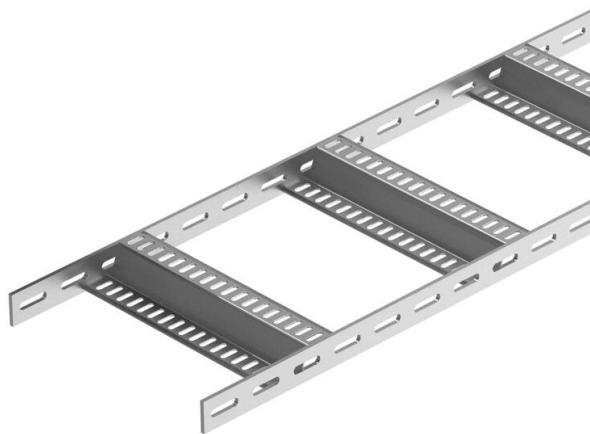

Shipbuilding cable ladder with perforated side rail of side height 40 mm with welded, perforated Z rungs. Load tested according to IEC in conjunction with connector, type SLV.

The shipbuilding cable ladder is also available in unpainted steel on request.



**A4** Stainless steel

**2B** Bright, treated

### Master data

Item number	7098228
Type	SLZ 400 A4
Description 1	Cable ladder, shipbuilding
Description 2	with Z-rung
Manufacturer	OBO
Dimension	40x410x3000
Material	Stainless steel
Surface	Bright, treated
Surface standard	
Smallest sales unit	3
Unit of quantity	Metre
Weight	479 kg
Weight unit	kg/100 m

# Technical data sheet

## Cable ladder with Z rung, standard A4

Item number: 7098228



### Dimensions

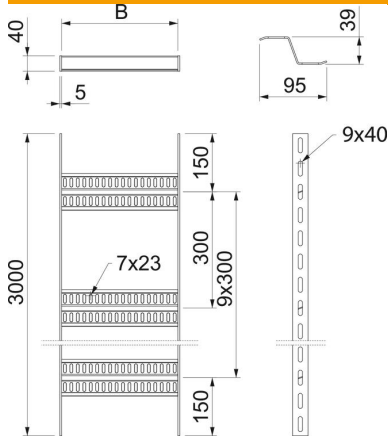

Dimension	40x400
Length	3,000 mm
Length	3,000 ft
Width	400 mm
Height	40 mm
Dimension B	410 mm

### Technical data

Version of the rungs	Profile perforated
Side rail version	Flat profile
Fastening of rung	Welded
Maintain electrical functions	no
Rustproof steel, pickled	yes
Side perforation	yes
Rung distance	300 mm
Wide-span version	no
Rail thickness	5 mm

### Loads

Support spacing 1.5 m	2.8 kN/m
Support spacing 2.0 m	1.5 kN/m
Support spacing 2.5 m	0.8 kN/m
Support spacing 3.0 m	0.5 kN/m

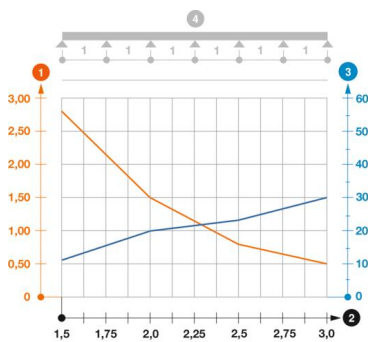

Load diagram, cable ladder, type SLZ A2 A4

- 1 Permitted cable tray/ladder load in kN/m without man load
- 2 Support width in m
- 3 Rail bend in mm at permitted kN/m
- Load curve with cable tray/ladder width in mm
- Strut bend curve according to support width
- 4 Load scheme during testing