

# Technical data sheet

## Aluminium pipe bend, without thread

Item number: 2046018



90° bend with moulded sleeves, for electrical installation pipes according to EN 61386-1. With burr-free inner wall.



**Alu** Aluminium

### Master data

Item number	2046018
Type	SB63W ALU
Description 1	Aluminium conduit bend
Description 2	without thread
Manufacturer	OBO
Dimension	Ø63mm
Material	Aluminium
Smallest sales unit	3
Unit of quantity	Piece
Weight	59.5 kg
Weight unit	kg/100 pc.

# Technical data sheet

## Aluminium pipe bend, without thread

Item number: 2046018



### Dimensions

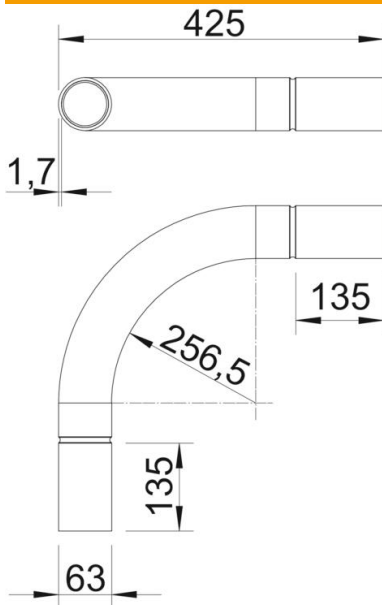

Dimension A	135 mm
Dimension B	425 mm
Dimension D	63 mm
Dimension I	70 mm
Dimension m (mm)	M63
Dimension R	225 mm
Dimension t	1.7 mm

### Technical data

Version for	Connector
Flexible	no
For nominal pipe diameter	63 mm
Halogen-free	no
With inspection opening and lid	no
With sleeve	yes
Brushed surface	no
Polished surface	no
Permitted temperature range, max.	250 °C
Permitted temperature range, min.	-45 °C
Angle of the bend	90 °
Two-part	no