

Technical data sheet

T branch piece 60 FS

Item number: 6043437



Horizontal T branch piece, for all cable tray types of 60 mm side height.
The fitting is shipped in an unmounted state. All the sides are designed for the same cable tray width.
Including appropriate fastening material.



- St** Steel
- FS** Strip galvanized

Master data

Item number	6043437
Type	RT 630 FS
Description 1	T-branch piece
Description 2	horizontal + angle connector
Manufacturer	OBO
Dimension	60x300
Material	Steel
Surface	Strip galvanized
Surface standard	DIN EN 10346
Smallest sales unit	1
Unit of quantity	Piece
Weight	198.2 kg
Weight unit	kg/100 pc.

Dimensions

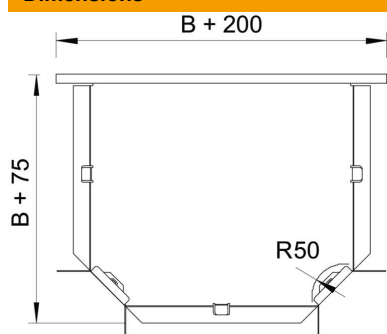

Width	300 mm
Width	12 in
Height	60 mm
Dimension B	300 mm
Dimension R	50 mm

Technical data sheet

T branch piece 60 FS

Item number: 6043437



Technical data

Bend (angle)	90°
Connector version	Supplied connectors
Maintain electrical functions	no
NATO hole pattern	no
Change of direction	Horizontal
Rustproof steel, pickled	no
Wide-span version	no
Type of connector, cable support system	Screwed
Rail thickness	1.25 mm