

# Technical data sheet

## T branch piece 60 FT

Item number: 7117209

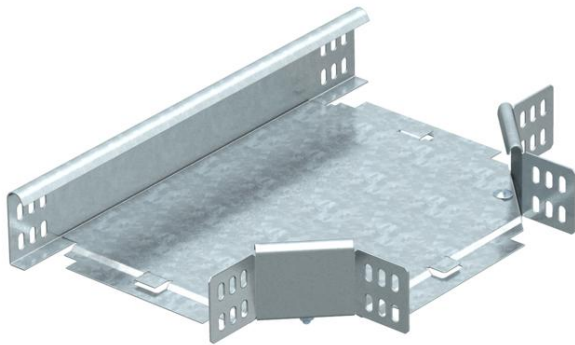

Horizontal T branch piece, for all cable tray types of 60 mm side height.  
The fitting is shipped in an unmounted state. All the sides are designed for the same cable tray width.  
Including appropriate fastening material.



**St** Steel

**FT** Hot-dip galvanised

### Master data

Item number	7117209
Type	RT 620 FT
Description 1	T-branch piece
Description 2	horizontal + angle connector
Manufacturer	OBO
Dimension	60x200
Material	Steel
Surface	Hot-dip galvanised
Surface standard	DIN EN ISO 1461
Smallest sales unit	1
Unit of quantity	Piece
Weight	144.8 kg
Weight unit	kg/100 pc.

### Dimensions

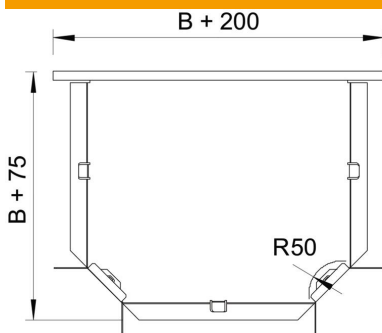

Width	200 mm
Width	8 in
Height	60 mm
Dimension B	200 mm
Dimension R	50 mm

# Technical data sheet

T branch piece 60 FT

Item number: 7117209



## Technical data

Bend (angle)	90°
Connector version	Supplied connectors
Maintain electrical functions	no
NATO hole pattern	no
Change of direction	Horizontal
Rustproof steel, pickled	no
Wide-span version	no
Type of connector, cable support system	Screwed
Rail thickness	1.25 mm