

Technical data sheet

110 FS cross-over

Item number: 7004664

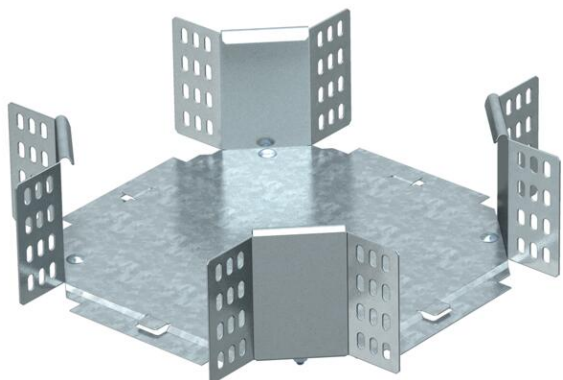

Horizontal cross-over for all cable tray types of 110 mm side height.
The fitting is shipped in an unmounted state. Including appropriate fastening material.



St Steel

FS Strip galvanized

Master data

Item number	7004664
Type	RK 120 FS
Description 1	Cross over
Description 2	horizontal + angle connector
Manufacturer	OBO
Dimension	110x200
Material	Steel
Surface	Strip galvanized
Surface standard	DIN EN 10346
Smallest sales unit	1
Unit of quantity	Piece
Weight	160 kg
Weight unit	kg/100 pc.

Technical data sheet

110 FS cross-over

Item number: 7004664



Dimensions

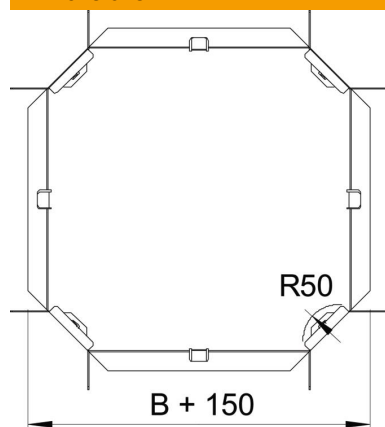

Width	200 mm
Width	8 in
Height	110 mm
Height	4 in
Dimension B	200 mm
Dimension R	50 mm

Technical data

Bend (angle)	90°
Connector version	Supplied connectors
Maintain electrical functions	no
Material thickness, floor plate	1 mm
Change of direction	Horizontal
Rustproof steel, pickled	no
Wide-span version	no
Type of connector, cable support system	Screwed
Rail thickness	1.25 mm