

Technical data sheet

Heavy-duty frame cassette for tube body, RKFSL, nominal size 250-3

Item number: 7409490



Heavy-duty frame cassette for tube body for the installation of accessories in the UZD250-3 in dry or wet-cleaned floors for indoor use. Load class 1 to 10 kN.

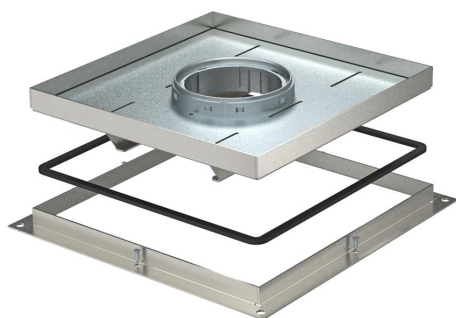

A2 Stainless steel

Master data

Item number	7409490
Type	RKF2 SL1 V2 40
Description 1	Heavy-duty frame cassette
Description 2	for tube
Manufacturer	OBO
Dimension	283x283x40
Material	Stainless steel
Smallest sales unit	1
Unit of quantity	Piece
Weight	559 kg
Weight unit	kg/100 pc.

Technical data sheet

Heavy-duty frame cassette for tube body, RKFSL, nominal size 250-3

Item number: 7409490



Dimensions

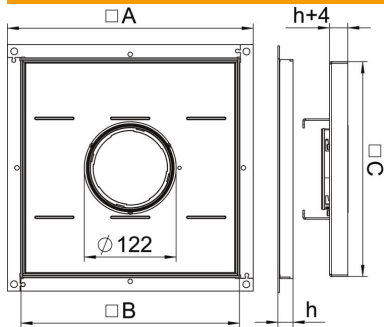

Dimension A	324 mm
Dimension B	288 mm
Dimension C	282 mm
Dimension h	40 mm

Technical data

Cable outlet version	Lowerable tube body
Suitable for raised floor installation	yes
Suitable for cavity floor installation	yes
Suitable for	Underfloor socket structure
Heavy-duty version	yes
Heavy load class	10 kN (OBO SL1)
Floor covering thickness	38 mm