

Technical data sheet

Adjustable bend element, vertical 60 FS

Item number: 7005369



Adjustable vertical bend element, for all cable tray types with a side height of 60 mm.
RGV 60 adjustable connectors should be ordered separately and in the appropriate quantity.
RGV 60 and SKS 8x16 hexagonal bolts should be ordered separately.



St Steel

FS Strip galvanized

Master data

Item number	7005369
Type	RGBEV 630 FS
Description 1	Adjustable bend element
Description 2	vertical
Manufacturer	OBO
Dimension	60x300
Material	Steel
Surface	Strip galvanized
Surface standard	DIN EN 10346
Smallest sales unit	1
Unit of quantity	Piece
Weight	80.4 kg
Weight unit	kg/100 pc.

Technical data sheet

Adjustable bend element, vertical 60 FS

Item number: 7005369



Dimensions

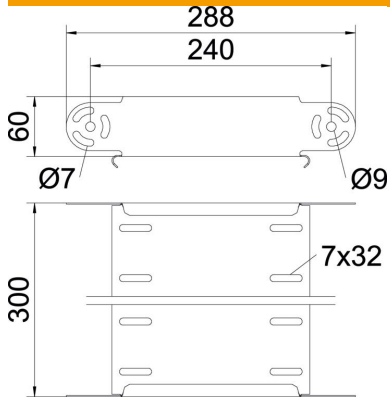

Width	300 mm
Width	12 in
Height	60 mm
Height	2 in
Plate thickness	1 mm
Dimension B	300 mm

Technical data

Bend (angle)	Adjustable
Connector version	Without connectors
Type	Adjustable bend element
Maintain electrical functions	yes
Mounting perforation in base	no
NATO hole pattern	no
Change of direction	Vertical, rising/falling
Rustproof steel, pickled	no
Side perforation	no
Wide-span version	no
Type of connector, cable support system	Screwed