

Technical data sheet

90° bend 60 A4

Item number: 7134288



90° bend, horizontal, for all cable tray types of 60 mm side height.
The fitting is shipped in an unmounted state.
Including appropriate fastening material.
The 100 mm width has a rectangle shape and does not correspond to the image.



A4 Stainless steel

2B Bright, treated

Master data

Item number	7134288
Type	RB 90 620 A4
Description 1	90° bend
Description 2	horizontal + angle connector
Manufacturer	OBO
Dimension	60x200
Material	Stainless steel
Surface	Bright, treated
Surface standard	
Smallest sales unit	1
Unit of quantity	Piece
Weight	111.9kg
Weight unit	kg/100 pc.

Technical data sheet

90° bend 60 A4

Item number: 7134288



Dimensions

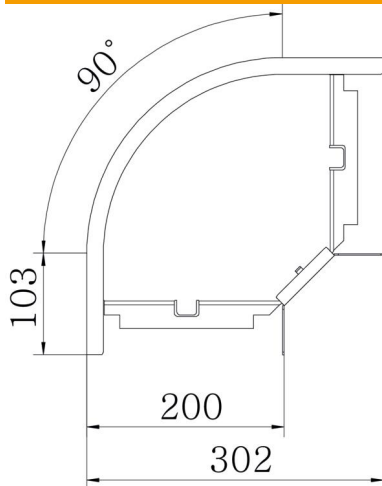

Width	200 mm
Width	8 in
Height	60 mm
Height	2 in
Plate thickness	1 mm
Dimension B	200 mm
Dimension R	50 mm

Technical data

Bend (angle)	90°
Connector version	Supplied connectors
Change of direction	Horizontal
Type of connector, cable support system	Screwed