

Technical data sheet

90° vertical bend, falling 35 FT

Item number: 7007210

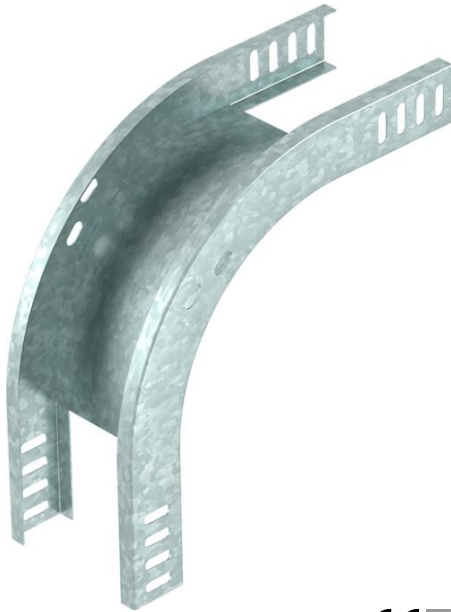

90° vertical bend, falling, for all cable tray types of 35 mm side height.

The vertical bend is pushed over the end of the cable tray and screwed tight. Fastening materials should be ordered separately.



St Steel

FT Hot-dip galvanised

Master data

Item number	7007210
Type	RBV 315 F FT
Description 1	90° vertical bend
Description 2	falling
Manufacturer	OBO
Dimension	35x150
Material	Steel
Surface	Hot-dip galvanised
Surface standard	DIN EN ISO 1461
Smallest sales unit	1
Unit of quantity	Piece
Weight	66 kg
Weight unit	kg/100 pc.

Technical data sheet

90° vertical bend, falling 35 FT

Item number: 7007210



Dimensions

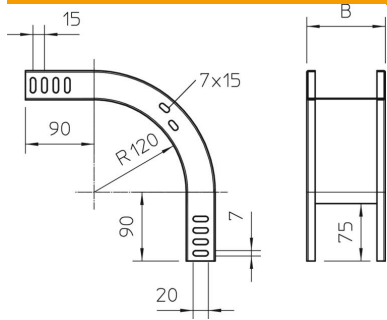

Width	150 mm
Width	6 in
Height	35 mm
Height	1 in
Plate thickness	1 mm
Dimension B	150 mm

Technical data

Bend (angle)	90°
Connector version	Without connectors
Change of direction	Vertical, falling
Type of connector, cable support system	Screwed