

# Technical data sheet

90° Magic bend 85 FT

Item number: 6041518



90° bend with quick connector system. For all cable tray types of 85 mm side height.

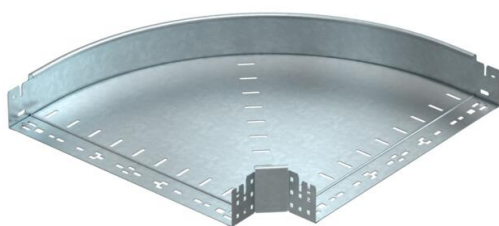

**St** Steel

**FT** Hot-dip galvanised

## Master data

Item number	6041518
Type	RBM 90 850 FT
Description 1	90° bend
Description 2	with quick connector
Manufacturer	OBO
Dimension	85x500
Material	Steel
Surface	Hot-dip galvanised
Surface standard	DIN EN ISO 1461
Smallest sales unit	1
Unit of quantity	Piece
Weight	434.6 kg
Weight unit	kg/100 pc.

# Technical data sheet

90° Magic bend 85 FT

Item number: 6041518



## Dimensions

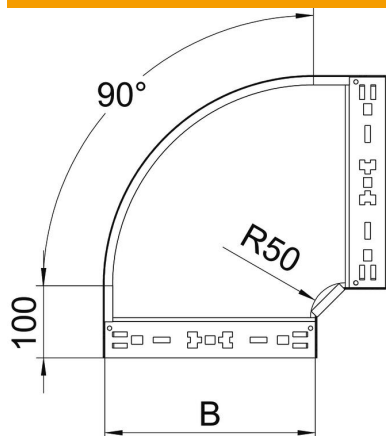

Width	500 mm
Height	85 mm
Plate thickness	1.25 mm
Dimension B	500 mm

## Technical data

Bend (angle)	90°
Connector version	Integrated connector
Maintain electrical functions	no
Mounting perforation in base	no
NATO hole pattern	no
Change of direction	Horizontal
Rustproof steel, pickled	no
Side perforation	no
Wide-span version	no
Type of connector, cable support system	Click fastening