

Technical data sheet

Trunking unit for GES9, height 60–110 mm

Item number: 7424722

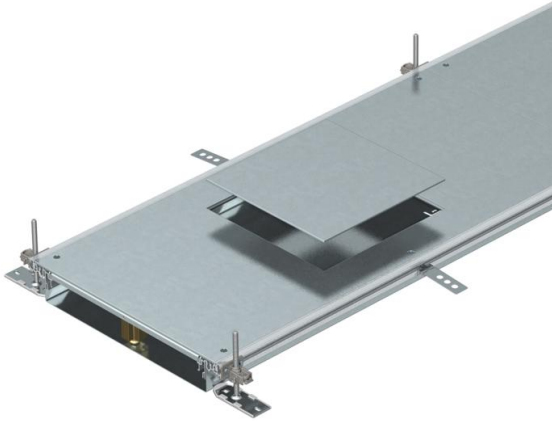

Ready-to-mount trunking unit with three or six device installation lids for cable laying and the installation of installation units of nominal size 9, consisting of the trunking base (floor trough with side and floor covering guide profiles) and trunking lid with blank mounting opening. Floor trough with holding shackles for self-contacting mounting of dividers. The scope of supply contains six height-adjustable wall fixing brackets, six screed anchors and three height-adjustable cover joint supports for nominal trunking widths 400 or six height-adjustable cover joint supports for nominal trunking widths 500 and 600. Trunking lid screwed down when delivered.

With three (for nominal trunking width 400, L = 800 mm) or six device installation lids (for nominal trunking widths 500 and 600, L = 400 mm) each with one installation opening for a square installation unit of nominal size 9 or 9/55.



St Steel

FS Strip galvanized

Master data

Item number	7424722
Type	OKA-W5006050D9
Description 1	Flushfloor trunking unit
Description 2	for service unit GES9
Manufacturer	OBO
Dimension	2400x500x60
Material	Steel
Surface	Strip galvanized
Surface standard	DIN EN 10346
Smallest sales unit	2.4
Unit of quantity	Metre
Weight	2168.8 kg
Weight unit	kg/100 m

Dimensions

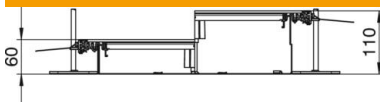

Length	2,400 mm
Width	500 mm

Technical data sheet

Trunking unit for GES9, height 60–110 mm

Item number: 7424722



Technical data

Mounting opening cover	yes
Covers	6
Number of insertable partitions	2
Number of planned flush-mount units	6
Number of compartments	3 St.
Mounting system fastening type	Floor
Floor plate	yes
Cover fastening, locking	no
Seal installation option	yes
Installation opening for on-floor tank	no
Decouplable	yes
Suitable for expansion joint	no
Mesh wall	no
Trunking height, max.	110 mm
Duct height, min.	60 mm
Cover material thickness	4
Minimum screed height	60
With connection opening	yes
With equipotential bonding	no
With separating retainer	no
With overhang	yes
Mounting opening	For service outlet
Mounting opening	Square
Nominal size for device installation units	9
Height-adjustment range, max.	110 mm
Height-adjustment range, min.	60 mm
Removable cover	yes
Separating retainer fastening	stecken
Separating retainer fastening	Plug