

Technical data sheet

Hammer-head bolt A4

Item number: 1148426



Hammer-head bolt for use with MS4121 and MS4141 profile rails

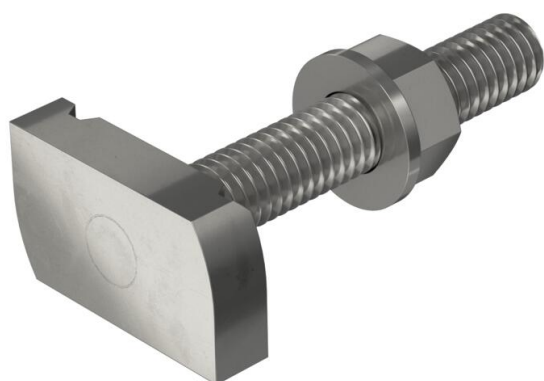

A4 Stainless steel

2B Bright, treated

Master data

Item number	1148426
Type	MS41HB M10x60 A4
Description 1	Hammerhead screw
Description 2	for profile rail MS4121/4141
Manufacturer	OBO
Dimension	M10x60mm
Material	Stainless steel
Surface	Bright, treated
Surface standard	
Smallest sales unit	25
Unit of quantity	Piece
Weight	9.2 kg
Weight unit	kg/100 pc.

Technical data sheet

Hammer-head bolt A4

Item number: 1148426



Dimensions

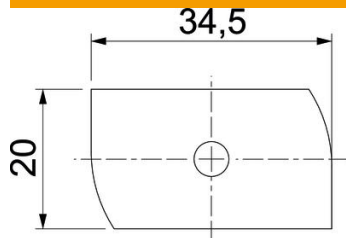

Length	34.5 mm
Width	20 mm
Height	8 mm
Dimension H	8 mm
Dimension L	60 mm

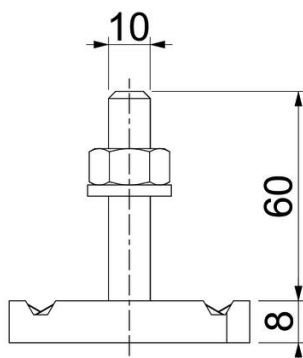

Technical data

Torque	9.9 Nm
Suitable for mounting rail	yes
Thread	M 10 x 60
Washer Ø	20 mm