

Technical data sheet

MS4121 mounting rail, slot 22 mm, double, A2, perforated

Item number: 1122954



Heavy-duty unistrut with continuous perforation in base, slot width 22 mm. Double version, i.e. two profile rails are interconnected on the base (welded).



A2 Stainless steel

2B Bright, treated

Master data

Item number	1122954
Type	MS4142P6000A2
Description 1	Profile rail
Description 2	perforated, slot 22mm
Manufacturer	OBO
Dimension	6000x41x42
Material	Stainless steel
Surface	Bright, treated
Surface standard	
Smallest sales unit	6
Unit of quantity	Metre
Weight	283.8 kg
Weight unit	kg/100 m

Technical data sheet

MS4121 mounting rail, slot 22 mm, double, A2, perforated

Item number: 1122954



Dimensions

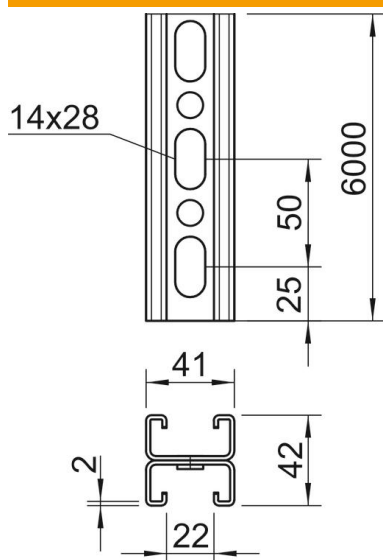

Length	6,000 mm
Width	41 mm
Height	42 mm
Dimension L	6,000 mm

Technical data

Breakable	no
Type of perforation	Perforated bar
Version for	Double profile
Maintain electrical functions	no
Hole size	14x28 mm
Material thickness	2 mm
With tothing	yes
Profile shape	C profile
Slot width	22 mm
Static value A	3.3 cm ²
Static value Iy	5.38 cm
Static value Iz	9.02 cm
Static value Wy	1.28 cm ²
Static value Wz	0.25 cm ²