

Technical data sheet

MS4121 mounting rail, slot 22 mm, FS, perforated

Item number: 1122920



Heavy-duty C profile rail for individual installation of support constructions, e.g. for cable trays or as a panel for switchgear cabinets. Can also be used for cable routing, in conjunction with clamp clips with a U foot.



St Steel

FS Strip galvanized

Master data

Item number	1122920
Type	MS4121P3000FS
Description 1	Profile rail
Description 2	perforated, slot 22mm
Manufacturer	OBO
Dimension	3000x41x21
Material	Steel
Surface	Strip galvanized
Surface standard	DIN EN 10346
Smallest sales unit	3
Unit of quantity	Metre
Weight	141.9 kg
Weight unit	kg/100 m

Technical data sheet

MS4121 mounting rail, slot 22 mm, FS, perforated

Item number: 1122920



Dimensions

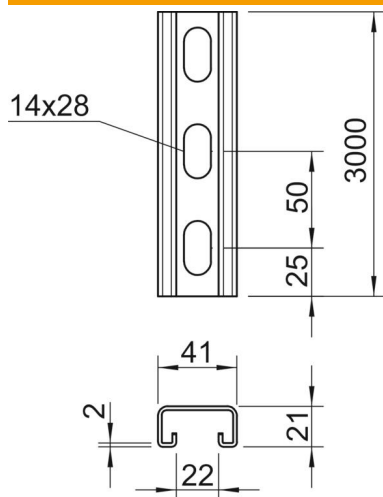

Length	3,000 mm
Width	41 mm
Height	21 mm
Dimension L	3,000 mm

Technical data

Breakable	no
Type of perforation	Perforated back
Version for	Single profile
Drill hole spacing, centre	50 mm
Maintain electrical functions	no
Hole size	14x28 mm
Material thickness	2 mm
With perforation	yes
With tothing	yes
Profile shape	C profile
Slot width	22 mm
Static value A	1.65 cm ²
Static value Iy	0.95 cm
Static value Iz	4.51 cm
Static value Wy	0.89 cm ²
Static value Wz	2.2 cm ²