

Technical data sheet

Hook-head screw A4

Item number: 1148146



Hook-head screw for use with MS4022 profile rail



A4 Stainless steel

2B Bright, treated

Master data

Item number	1148146
Type	MS40HB M6x30 A4
Description 1	Hook-head screw
Description 2	for profile rail MS4022
Manufacturer	OBO
Dimension	M6x30mm
Material	Stainless steel
Surface	Bright, treated
Surface standard	
Smallest sales unit	50
Unit of quantity	Piece
Weight	4.8 kg
Weight unit	kg/100 pc.

Technical data sheet

Hook-head screw A4

Item number: 1148146



Dimensions

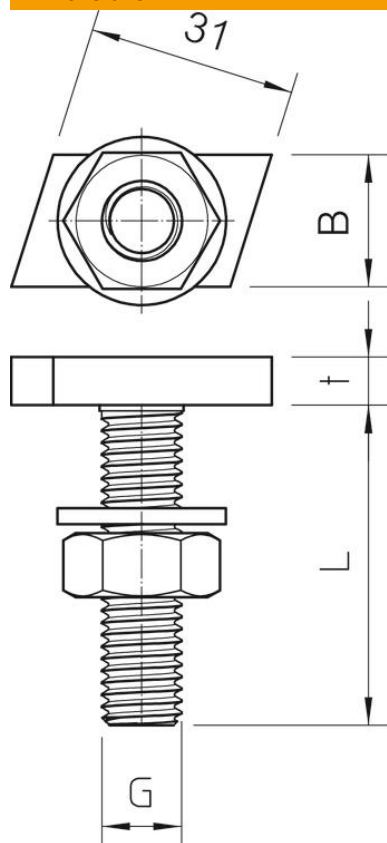

Length	35 mm
Width	17 mm
Height	10 mm

Technical data

Torque	2.9 Nm
Suitable for mounting rail	yes
Thread	M6x30mm
Thread metric	6