

# Technical data sheet

## Hook-head screw A4

Item number: 1148168



Hook-head screw for use with MS4022 profile rail



**A4** Stainless steel

**2B** Bright, treated

### Master data

Item number	1148168
Type	MS40HB M12x30 A4
Description 1	Hook-head screw
Description 2	for profile rail MS4022
Manufacturer	OBO
Dimension	M12x30mm
Material	Stainless steel
Surface	Bright, treated
Surface standard	
Smallest sales unit	50
Unit of quantity	Piece
Weight	7.55 kg
Weight unit	kg/100 pc.

# Technical data sheet

## Hook-head screw A4

Item number: 1148168



### Dimensions

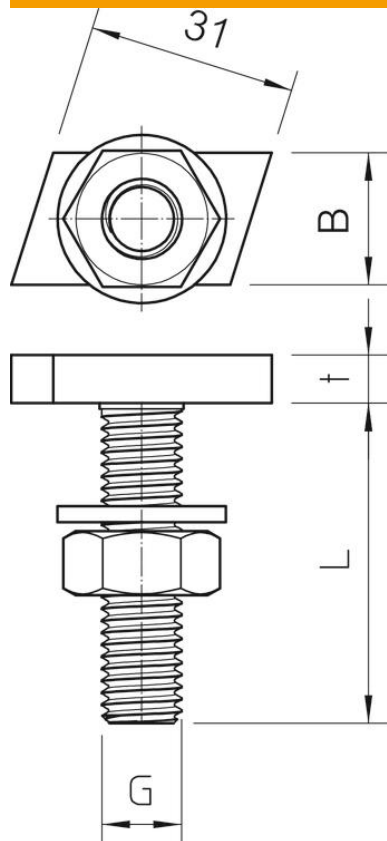

Length	35 mm
Width	14 mm
Height	7.5 mm

### Technical data

Torque	24 Nm
Suitable for mounting rail	yes
Thread	M12x30mm
Thread metric	12