

Technical data sheet

90° bend 15 FS, shipbuilding

Item number: 7061050



90° horizontal bend, for all ship construction cable tray types, produced according to the marine standard VG 88900-2.



St Steel

FS Strip galvanized

Master data

Item number	7061050
Type	MKRB 90 15 075FS
Description 1	90° bend
Description 2	for cable tray marine standard
Manufacturer	OBO
Dimension	B75mm
Material	Steel
Surface	Strip galvanized
Surface standard	DIN EN 10346
Smallest sales unit	1
Unit of quantity	Piece
Weight	22.5 kg
Weight unit	kg/100 pc.

Technical data sheet

90° bend 15 FS, shipbuilding

Item number: 7061050



Dimensions

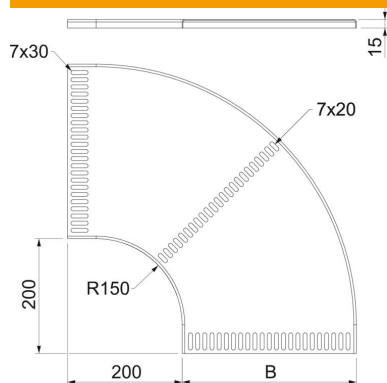

Width	76 mm
Height	15 mm
Plate thickness	1.25 mm
Dimension B	76 mm

Technical data

Bend (angle)	90°
Connector version	Without connectors
Type	Bend, rigid
Maintain electrical functions	no
Mounting perforation in base	yes
NATO hole pattern	yes
Change of direction	Horizontal
Rustproof steel, pickled	no
Side perforation	no
Wide-span version	no
Type of connector, cable support system	Screwed