

Technical data sheet

Centre suspension, universal FS

Item number: 6358864



Universal centre suspension for fastening to threaded rods and supports.
Preferred use of this centre suspension in combination with cable ladders and mesh cable trays.



St Steel

FS Strip galvanized

Master data

Item number	6358864
Type	MAHU 500 FS
Description 1	Centre suspension
Description 2	universal
Manufacturer	OBO
Dimension	B500mm
Material	Steel
Surface	Strip galvanized
Surface standard	DIN EN 10346
Smallest sales unit	1
Unit of quantity	Piece
Weight	85.8 kg
Weight unit	kg/100 pc.

Technical data sheet

Centre suspension, universal FS

Item number: 6358864



Dimensions

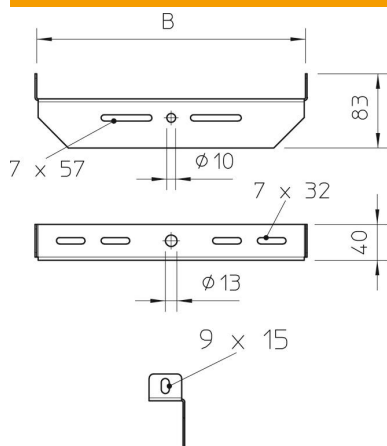

Width	500 mm
Dimension B	500 mm

Technical data

Version for	Miscellaneous
Maintain electrical functions	no
Suitable for metric threaded rod	12
Suitable for mesh cable tray	yes
Suitable for cable ladder	yes
Suitable for cable tray	yes
Suitable for tray/ladder width	500 mm
Tray fastening	Screw-on
Adjustable	no