

# Technical data sheet

## Drop-out plate A2

Item number: 7164068



Exit plate for installation on the rung for vertically exiting cables.

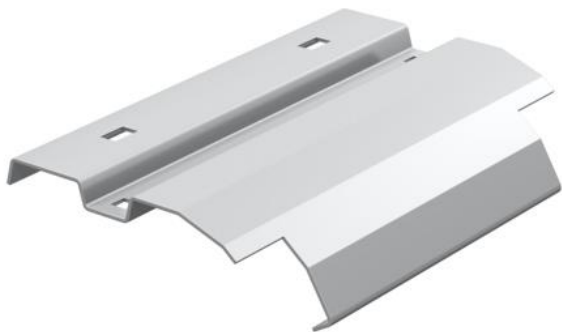

**A2** Stainless steel

**2B** Bright, treated

### Master data

Item number	7164068
Type	LAB 60 A2
Description 1	Outgoing plate
Description 2	for cable ladder
Manufacturer	OBO
Dimension	B600mm
Material	Stainless steel
Surface	Bright, treated
Surface standard	
Smallest sales unit	1
Unit of quantity	Piece
Weight	75 kg
Weight unit	kg/100 pc.

### Dimensions

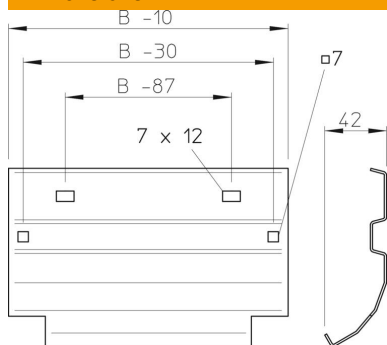

Width	600 mm
Height	45 mm
Plate thickness	1 mm