

Technical data sheet

Drop-out plate A2

Item number: 7164017



Exit plate for installation on the rung for vertically exiting cables.



A2 Stainless steel

2B Bright, treated

Master data

Item number	7164017
Type	LAB 20 A2
Description 1	Outgoing plate
Description 2	for cable ladder
Manufacturer	OBO
Dimension	B200mm
Material	Stainless steel
Surface	Bright, treated
Surface standard	
Smallest sales unit	1
Unit of quantity	Piece
Weight	26 kg
Weight unit	kg/100 pc.

Dimensions

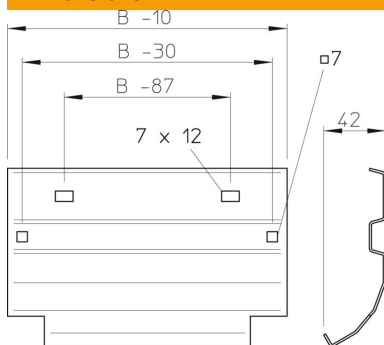

Width	200 mm
Height	45 mm
Plate thickness	1 mm