

Technical data sheet

Clamping angle KWH FT

Item number: 6355021



Clamping angle, with hook-head bolt, type KWH, for fastening in the mounting rail, type MS5030.
Adapt the clamping angle to the material thickness of the flange.

The clamping angle is used in conjunction with profile rails of slot width 22 mm.

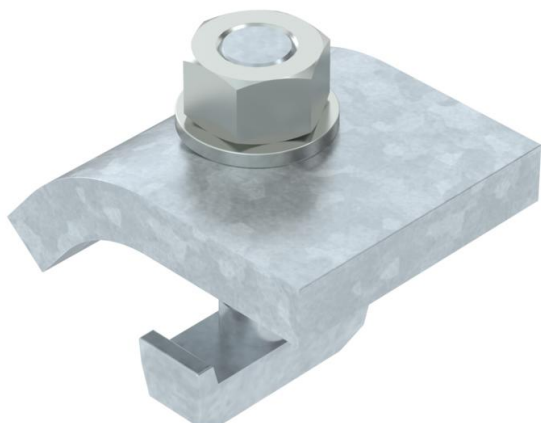

St Steel

FT Hot-dip galvanised

Master data

Item number	6355021
Type	KWH 5 FT
Description 1	Clamping profile
Description 2	with hook screw, h = 5 mm
Manufacturer	OBO
Dimension	60x50
Material	Steel
Surface	Hot-dip galvanised
Surface standard	DIN EN ISO 1461
Smallest sales unit	10
Unit of quantity	Pair
Weight	67 kg
Weight unit	kg/100 pairs

Technical data sheet

Clamping angle KWH FT

Item number: 6355021



Dimensions

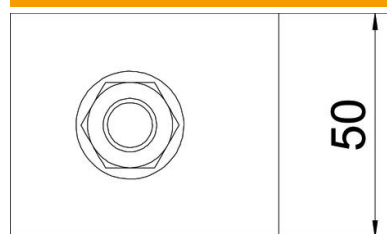

Height 5 mm

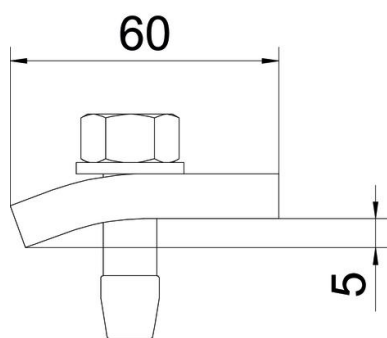

Technical data

F in kN	5.7 kN
Suitable for flange thickness, max.	8 mm
Suitable for flange thickness, min.	3 mm
Thread metric	12
Bolt	M12 x 40