

Technical data sheet

Edge protection ring KSR 20020, for LKM cable trunking type LKM 20020

Item number: 6249842



Edge protection ring for the open ends of LKM cable trunking.



PVC Polyvinylchloride

Master data

Item number	6249842
Type	KSR20020
Description 1	Edge protection ring
Description 2	for LKM trunking
Manufacturer	OBO
Dimension	20x20mm
Colour	Grey
Material	Polyvinylchloride
Smallest sales unit	5
Unit of quantity	Piece
Weight	0.9 kg
Weight unit	kg/100 pc.

Technical data sheet

Edge protection ring KSR 20020, for LKM cable trunking type LKM 20020

Item number: 6249842



Dimensions

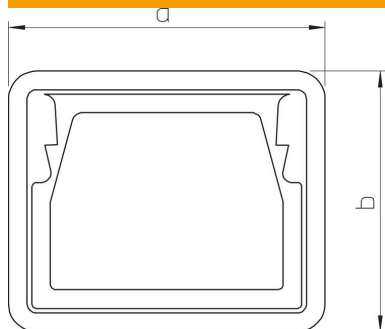

Length	23 mm
Width	24 mm
Height	28 mm
Dimension a	24 mm
Dimension b	28 mm

Technical data

Type	Injection-moulded part
Suitable for	Cable routing duct
Halogen-free	yes
Protection rating	IP30
Protection rating IK code	IK10
Permitted temperature range, max.	90 °C
Permitted temperature range, min.	-5 °C