

# Technical data sheet

## Hold-down clamp w. press plate 32 A2

Item number: 6221065



Hold-down clamp for position fixing of horizontal cable ladders on horizontal steel girders.

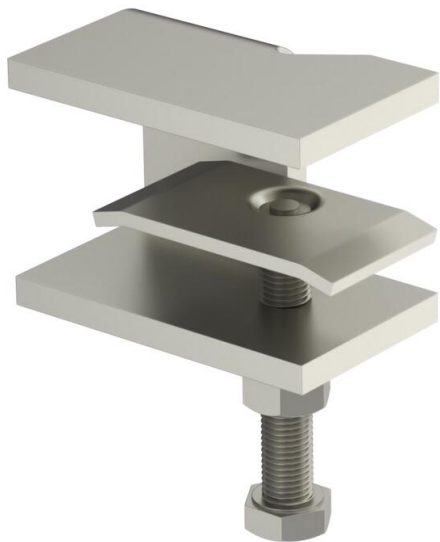

**A2** Stainless steel

**2B** Bright, treated

### Master data

Item number	6221065
Type	KLL 32 MD A2
Description 1	Hold-down clamp w. press plate
Description 2	for cable ladder
Manufacturer	OBO
Dimension	32x88x5
Material	Stainless steel
Surface	Bright, treated
Surface standard	
Smallest sales unit	10
Unit of quantity	Piece
Weight	24.6 kg
Weight unit	kg/100 pc.

# Technical data sheet

Hold-down clamp w. press plate 32 A2

Item number: 6221065



## Dimensions

