

Technical data sheet

90° mesh cable tray bend FT

Item number: 6002358



90° bend, horizontal, for all mesh cable trays of 105 mm side height.

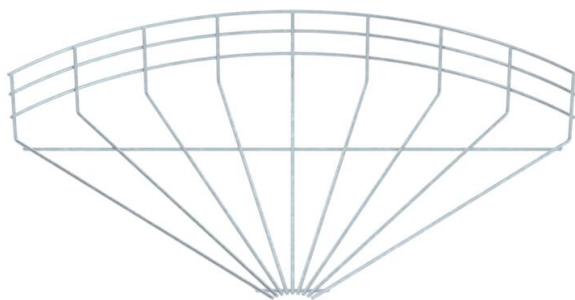

St Steel

FT Hot-dip galvanised

Master data

Item number	6002358
Type	GRB 90 150 FT
Description 1	90° mesh cable tray bend
Manufacturer	OBO
Dimension	105x500
Material	Steel
Surface	Hot-dip galvanised
Surface standard	DIN EN ISO 1461
Smallest sales unit	1
Unit of quantity	Piece
Weight	116.8 kg
Weight unit	kg/100 pc.

Technical data sheet

90° mesh cable tray bend FT

Item number: 6002358



Dimensions

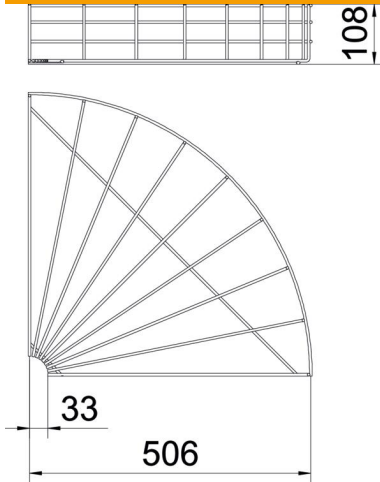

Width	500 mm
Width	19.69 in
Height	105 mm
Dimension A	33 mm
Dimension B	506 mm
Dimension H	108 mm

Technical data

Bend (angle)	90°
Connector version	Without connectors
Type	Horizontal bend
Maintain electrical functions	no
Rustproof steel, pickled	no