

Technical data sheet

Hook rail for G mesh cable tray FS

Item number: 6005615



Hook rail for wall mounting of G mesh cable trays



CE

St Steel

FS Strip galvanized

Master data

Item number	6005615
Type	G-GRM-R150 FS
Description 1	Hook rail
Description 2	for G mesh cable tray mounting
Manufacturer	OBO
Dimension	110x25x15
Material	Steel
Surface	Strip galvanized
Surface standard	DIN EN 10346
Smallest sales unit	25
Unit of quantity	Piece
Weight	4.8 kg
Weight unit	kg/100 pc.

Technical data sheet

Hook rail for G mesh cable tray FS

Item number: 6005615



Dimensions

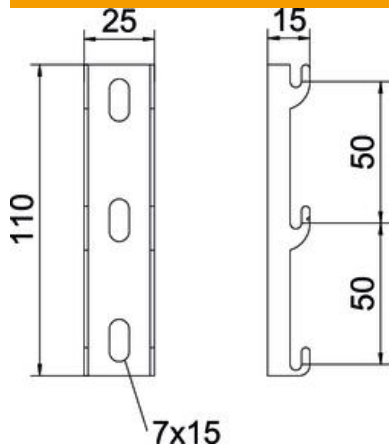

Length	110 mm
Width	25 mm
Width	0.98 in
Height	15 mm

Technical data

Suitable for profile shapes	U-shaped
Profile shape	U-shaped
Rustproof steel, pickled	no