

Technical data sheet

Cover for 45° bend FS

Item number: 7128827



Cover for 45° bend with pre-mounted turn buckle.
The cover can be used with fittings of all side heights.



St	Steel
FS	Strip galvanized

Master data

Item number	7128827
Type	DFB 45 150 FS
Description 1	45° bend cover
Description 2	with sash locks, RB 45 150
Manufacturer	OBO
Dimension	B150mm
Material	Steel
Surface	Strip galvanized
Surface standard	DIN EN 10346
Smallest sales unit	1
Unit of quantity	Piece
Weight	27.8 kg
Weight unit	kg/100 pc.

Dimensions

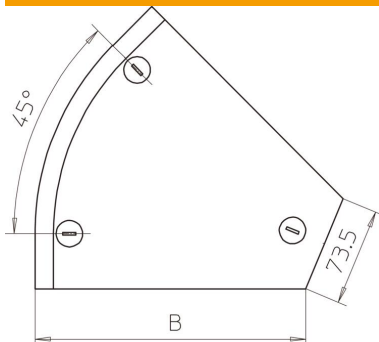

Width	150 mm
Width	6 in
Height	35 mm
Plate thickness	0.04 in
Plate thickness	1 mm
Dimension B	150 mm
Dimension H	15 mm

Technical data sheet

Cover for 45° bend FS

Item number: 7128827



Technical data

Bend (angle)	45°
Number of turn buckles	3 St.
Fastening type	Sash lock
Maintain electrical functions	no
Suitable for mesh cable tray	no
Suitable for cable ladder	no
Suitable for cable tray	yes
Change of direction	Horizontal
Rustproof steel, pickled	no
Hinged	no