

Technical data sheet

Cover for 90° Magic bend A2



Item number: 7138576

Cover for 90° bend with pre-mounted turn buckles.
The cover can be used with fittings of all side heights.



A2 Stainless steel

2B Bright, treated

Master data

Item number	7138576
Type	DFBM 90 300 A2
Description 1	90° bend cover
Description 2	for bend RBM 90 300
Manufacturer	OBO
Dimension	B=300mm
Material	Stainless steel
Surface	Bright, treated
Surface standard	
Smallest sales unit	1
Unit of quantity	Piece
Weight	83 kg
Weight unit	kg/100 pc.

Technical data sheet

Cover for 90° Magic bend A2

Item number: 7138576



Dimensions

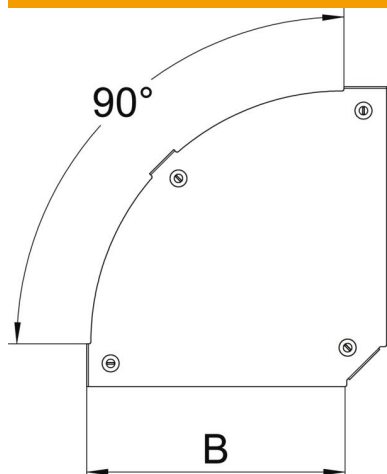

Width	300 mm
Plate thickness	1.25 mm
Dimension B	300 mm

Technical data

Bend (angle)	90°
Fastening type	Sash lock
Maintain electrical functions	no
Suitable for mesh cable tray	no
Suitable for cable ladder	yes
Suitable for cable tray	yes
Change of direction	Horizontal
Rustproof steel, pickled	no
Hinged	no