

Technical data sheet

Spacer clip 733 G

Item number: 1362756



Spacer clip for the installation of pipes and cables on walls, ceilings and floors. With self-locking cover. Fastening via slot.

Approved for the maintenance of electrical function according to DIN 4102 Part 12, maintenance of electrical function classes E 30 to E 90.



St Steel

G Electrogalvanized

Master data

Item number	1362756
Type	ASL 733 12 G
Description 1	Distance saddle
Description 2	with slot
Manufacturer	OBO
Dimension	10-12mm
Material	Steel
Surface	Electrogalvanized
Surface standard	EN ISO 19598 / EN ISO 4042
Smallest sales unit	25
Unit of quantity	Piece
Weight	1.857 kg
Weight unit	kg/100 pc.

Technical data sheet

Spacer clip 733 G

Item number: 1362756



Dimensions

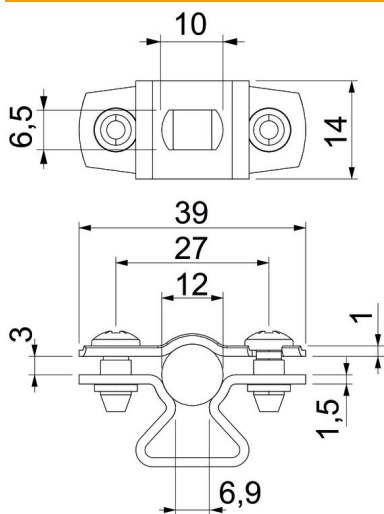

Dimension A	39 mm
Dimension B	27 mm
Dimension b	14 mm
Dimension D	12 mm
Dimension d max.	12 mm
Dimension d min.	10 mm
Dimension L	10 mm
Dimension s	6.9 mm
Dimension t1 (mm)	1
Dimension t2 (mm)	1.5
Dimension x	3 mm

Technical data

Distance to the wall	yes
Number of cables/pipes	1
Version for	Closed
Fastening type	Screw hole
For diameter	10 - 12
Suitable in fire protection area	no
Halogen-free	yes
Plastic-covered	no
Material thickness	1.5 mm
Clamping range D, max.	12 mm
Clamping range D, min.	10 mm
UV-resistant	yes