

Technical data sheet

Connection cable – AL EX ISG

Item number: 5240106



UV-resistant connection cable (copper 25 mm²) for mounting the OBO Ex spark gap, type EX ISG, on insulating flanges and insulating pieces. With cable shoe for M10 bolts on both sides, on one side with M10 bolt, nuts and spring ring.



Cu Copper

Master data

Item number	5240106
Type	AL EX ISG 300
Description 1	Connecting cable
Description 2	for EX ISG H
Manufacturer	OBO
Dimension	300mm
Material	Copper
Smallest sales unit	1
Unit of quantity	Piece
Weight	15.2 kg
Weight unit	kg/100 pc.

Technical data sheet

Connection cable – AL EX ISG

Item number: 5240106



Dimensions

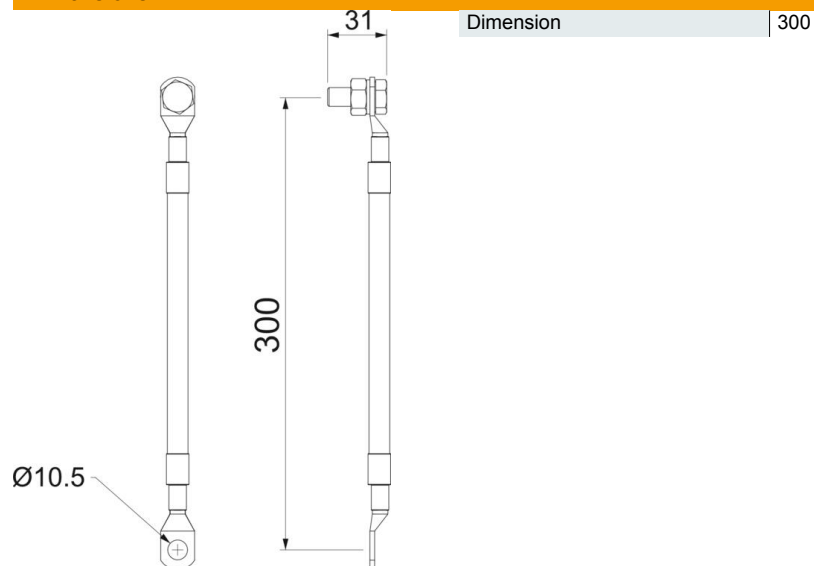

Technical data

Connecting cable length	0.3 m
Accessories	yes
Spare part	no
Type of accessory, accessory for surge protection, energy technology	Connection cable