

Technical data sheet

Hammer-head bolt ZL

Item number: 1148064



Hammer-head bolt for use with CM3015, CM3518 and AM3518 profile rails



St Steel

ZL Zinc slat

Master data

Item number	1148064
Type	ACMHB M8x60 ZL
Description 1	Hammerhead screw
Description 2	for profile rails, medium
Manufacturer	OBO
Dimension	M8x60mm
Material	Steel
Surface	Zinc slat
Surface standard	
Smallest sales unit	25
Unit of quantity	Piece
Weight	4.65 kg
Weight unit	kg/100 pc.

Technical data sheet

Hammer-head bolt ZL

Item number: 1148064



Dimensions

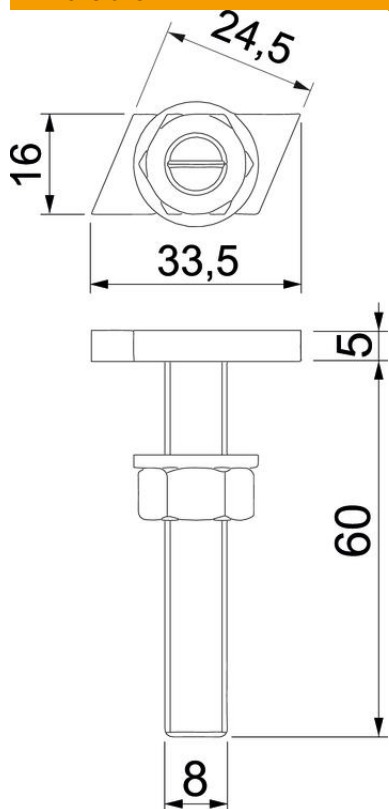

Length	33.5 mm
Width	16 mm
Height	5 mm
Dimension L	60 mm

Technical data

Suitable for mounting rail	yes
Thread	M 8 x 60mm
Thread metric	8