

# Technical data sheet

## Hammer-head bolt A4

Item number: 1148076



Hammer-head bolt for use with CM3015, CM3518 and AM3518 profile rails



**A4** Stainless steel

**2B** Bright, treated

### Master data

Item number	1148076
Type	ACMHB M6x30 A4
Description 1	Hammerhead screw
Description 2	for profile rails, medium
Manufacturer	OBO
Dimension	M6x30mm
Material	Stainless steel
Surface	Bright, treated
Surface standard	
Smallest sales unit	50
Unit of quantity	Piece
Weight	2.6 kg
Weight unit	kg/100 pc.

# Technical data sheet

## Hammer-head bolt A4

Item number: 1148076



### Dimensions

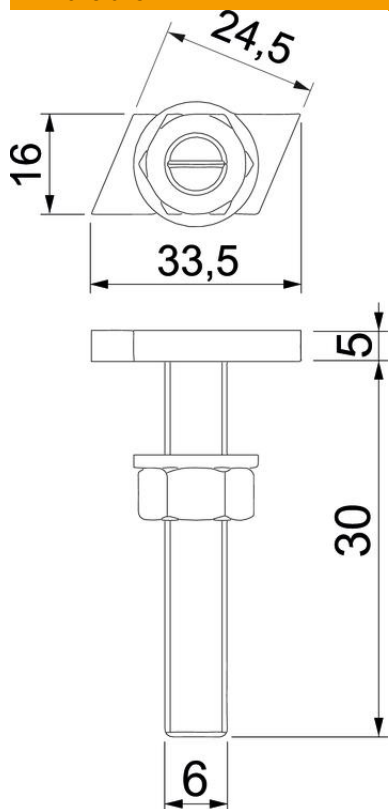

Length	33.5 mm
Width	16 mm
Height	5 mm
Dimension L	30 mm

### Technical data

Suitable for mounting rail	yes
Thread	M 6 x 30mm
Thread metric	6