

Technical data sheet

Screw-in nipple, metric thread, with perforation membrane

Item number: 2032388



With perforation membranes, the opening D is pre-marked, but closed.

Grip seal to screw into metric thread to IEC 423.

With self-sealing cone at the end of the thread, therefore no connection thread sealing ring required.

Protection rating achievable with careful mounting: IP54.

With perforation membranes, the opening D is pre-marked, but closed.



PE Polyethylene

Master data

Item number	2032388
Type	90 M40 GE
Description 1	Screw-in nipple
Description 2	closed version
Manufacturer	OBO
Dimension	M40
Colour	Light grey; RAL 7035
Material	Polyethylene
Smallest sales unit	10
Unit of quantity	Piece
Weight	0.875 kg
Weight unit	kg/100 pc.

Technical data sheet

Screw-in nipple, metric thread, with perforation membrane



Item number: 2032388

Dimensions

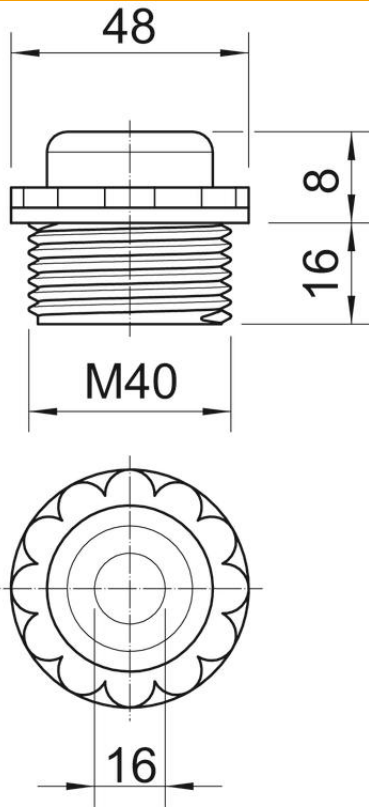

Dimension D	16 mm
Dimension E	48 mm
Dimension L1	16 mm
Dimension L2	8 mm

Technical data

Thread length	16 mm
Size	M40
Halogen-free	yes
WAF	44
Protection rating	IP54