

Technical data sheet

Screw-in nipple, metric thread, with opening

Item number: 2032023



With open cable entry.

Grip seal to screw into metric thread end to IEC 423.

With self-sealing cone at the end of the thread, therefore no connection thread sealing ring required.

Protection rating achievable with careful mounting: IP54.
With open cable entry.



PE Polyethylene

Master data

Item number	2032023
Type	90 M32 OF
Description 1	Screw-in nipple
Description 2	open version
Manufacturer	OBO
Dimension	M32
Colour	Light grey; RAL 7035
Material	Polyethylene
Smallest sales unit	25
Unit of quantity	Piece
Weight	0.694 kg
Weight unit	kg/100 pc.

Technical data sheet

Screw-in nipple, metric thread, with opening

Item number: 2032023



Dimensions

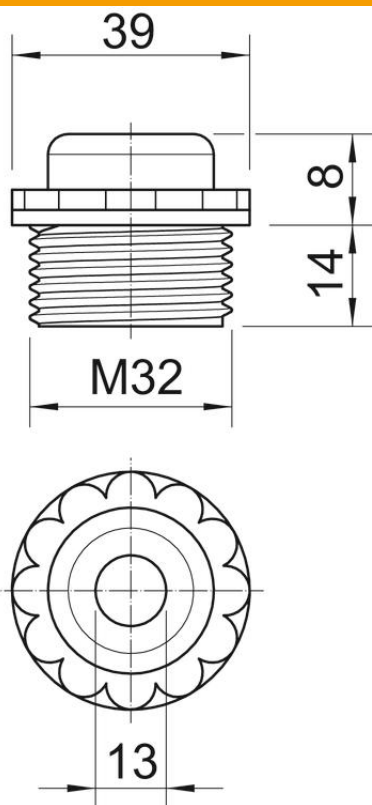

Dimension D	13 mm
Dimension E	39 mm
Dimension L1	14 mm
Dimension L2	8 mm

Technical data

Thread length	14 mm
Size	M32
Halogen-free	yes
WAF	34
Protection rating	IP54