

Technical data sheet

Screw-in nipple, metric thread, with perforation membrane

Item number: 2032384



With perforation membranes, the opening D is pre-marked, but closed.
Grip seal to screw into metric thread to IEC 423.
With self-sealing cone at the end of the thread, therefore no connection thread sealing ring required.
Protection rating achievable with careful mounting: IP54.
With perforation membranes, the opening D is pre-marked, but closed.



PE Polyethylene

Master data

Item number	2032384
Type	90 M25 GE
Description 1	Screw-in nipple
Description 2	closed version
Manufacturer	OBO
Dimension	M25
Colour	Light grey; RAL 7035
Material	Polyethylene
Smallest sales unit	50
Unit of quantity	Piece
Weight	0.513 kg
Weight unit	kg/100 pc.

Technical data sheet

Screw-in nipple, metric thread, with perforation membrane



Item number: 2032384

Dimensions

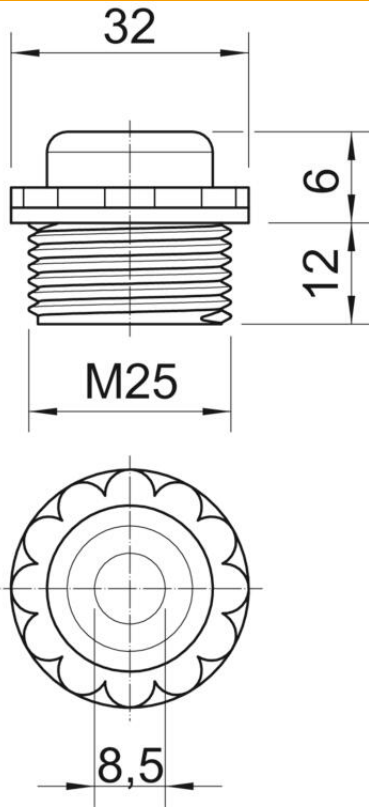

Dimension D	8.5 mm
Dimension E	32 mm
Dimension L1	12 mm
Dimension L2	6 mm

Technical data

Thread length	12 mm
Size	M25
Halogen-free	yes
WAF	30
Protection rating	IP54