

Technical data sheet

OBO anchor

Item number: 3105032



Hardened steel, shiny without thread.



CE

St Steel

Master data

Item number	3105032
Type	903 RB 22
Description 1	OBO plug
Description 2	knock-in anchor,without thread
Manufacturer	OBO
Dimension	L22mm
Material	Steel
Smallest sales unit	200
Unit of quantity	Piece
Weight	0.325 kg
Weight unit	kg/100 pc.

Technical data sheet

OBO anchor

Item number: 3105032



Dimensions

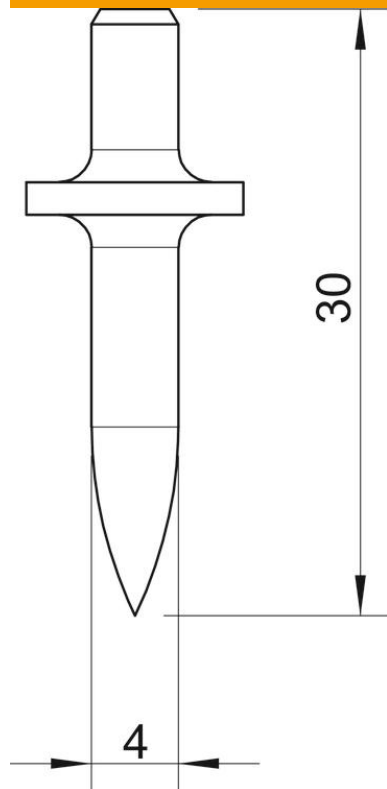

Length	30 mm
Dimension d min.	4 mm
Dimension L	30 mm

Technical data

Flange diameter	10 mm
Hardened	yes
Shank length	22