

# Technical data sheet

## Sprint screw, with Torx

Item number: 3198245



Hardened steel, electrogalvanised and Hostaflon-coated. Countersunk head with T bit (six lobe head), sizes Ø 3 mm T10, Ø 3.5 mm T15, Ø 4 and 4.5 mm T20, Ø 5 mm T25.

The use of Sprint screws leads to considerably reduced screw-in times compared with standard screws. This noticeable advantage comes from the point with the first thread, which leads on to the double thread beyond.

Areas of use: wood, chipboard, Rigips panels, plastic anchors.



**St** Steel

**G** Electrogalvanized

### Master data

Item number	3198245
Type	4759T 4.0x35
Description 1	Sprint screw
Description 2	countersunk head, T-drive
Manufacturer	OBO
Dimension	4x35mm
Material	Steel
Surface	Electrogalvanized
Surface standard	EN ISO 19598 / EN ISO 4042
Smallest sales unit	200
Unit of quantity	Piece
Weight	0.197 kg
Weight unit	kg/100 pc.

# Technical data sheet

## Sprint screw, with Torx

Item number: 3198245



### Dimensions

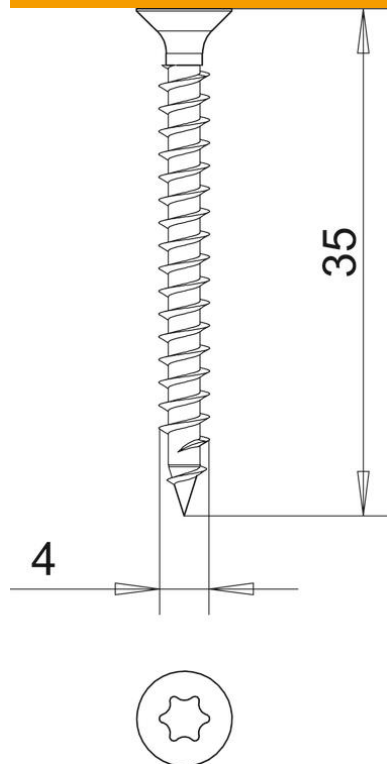

Length	35 mm
Dimension D	4 mm
Dimension L	35 mm

### Technical data

Hardened	yes
Head diameter	7.5 mm
Head shape	Countersunk head
Screw system	Torx