

Technical data sheet

Beam clamp, for profile rail CM3518

Item number: 1408011

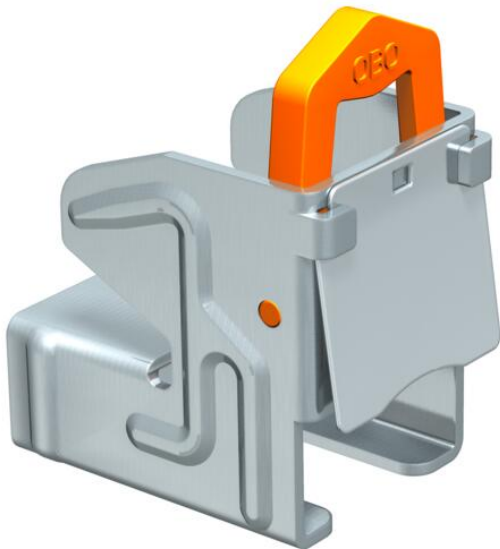

Screwless rustproof coated beam clamp, with blocking spring, suitable for profile rail, type CML3518 and CMS3518. For rapid fastening to steel profiles when installing cable tracks, clamp clips, light mounts, etc. A complete system consists of 2 beam clamps and one piece of C profile rail of any length, and 2 end caps.

CE

St	Steel
ZL	Zinc slat

Master data

Item number	1408011
Type	328 1
Description 1	Beam clamp
Description 2	with retaining spring
Manufacturer	OBO
Dimension	5-11mm
Material	Steel
Surface	Zinc slat
Surface standard	
Smallest sales unit	50
Unit of quantity	Piece
Weight	10.8 kg
Weight unit	kg/100 pc.

Technical data sheet

Beam clamp, for profile rail CM3518

Item number: 1408011



Dimensions

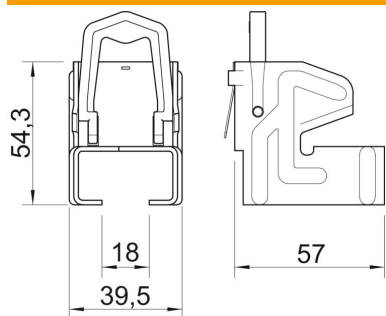

Length	57 mm
Width	39.5 mm
Height	54.3 mm
Dimension B	39.5 mm
Dimension H	54.3 mm
Dimension L	57 mm

Technical data

Connection type/component	Miscellaneous
Fastening type	Clamp
Flange thickness F max.	11 mm
Flange thickness F min.	5 mm
Hinge, adjustable	no
Hinged	no