

Technical data sheet

Grip ISO clip, single

Item number: 2105055

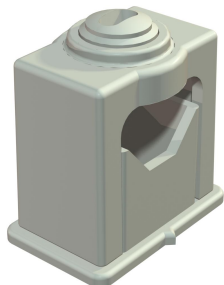

Solid cable fastening through clamping screws, with adhesive base, slot and for screwing to M6 thread.

Use the Impu-Fix ribbon conductor quick adhesive, type 509, to stick the polystyrene clips to masonry and concrete.



PS Polystyrene

Master data

Item number	2105055
Type	3042 LGR
Description 1	Grip ISO clip
Manufacturer	OBO
Dimension	24-34mm
Colour	Light grey; RAL 7035
Material	Polystyrene
Smallest sales unit	25
Unit of quantity	Piece
Weight	2.488 kg
Weight unit	kg/100 pc.

Technical data sheet

Grip ISO clip, single

Item number: 2105055



Dimensions

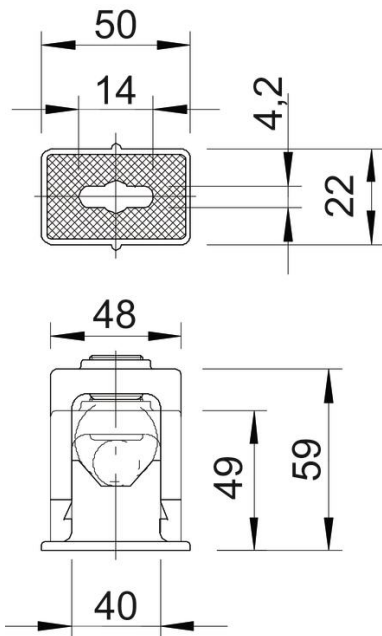

Dimension a	50 mm
Dimension a1 (mm)	14 mm
Dimension b	22 mm
Dimension b1	4.2 mm
Dimension c	48 mm
Dimension d	49 mm
Dimension e	59 mm
Dimension f	40 mm

Technical data

Expandable	no
Number of cables/pipes	1
Fastening type	Screw hole
Halogen-free	yes
Snap system	yes
Impact-resistant	yes
Clamping range D, max.	34 mm
Clamping range D, min.	24 mm