

Technical data sheet

ISO base clip

Item number: 2130548



ISO base clip 50.5–54 mm



PS Polystyrene

Master data

Item number	2130548
Type	2960 54 M6 LGR
Description 1	ISO base clip
Manufacturer	OBO
Dimension	50,5-54mm
Colour	Light grey; RAL 7035
Material	Polystyrene
Smallest sales unit	15
Unit of quantity	Piece
Weight	4.524 kg
Weight unit	kg/100 pc.

Technical data sheet

ISO base clip

Item number: 2130548



Dimensions

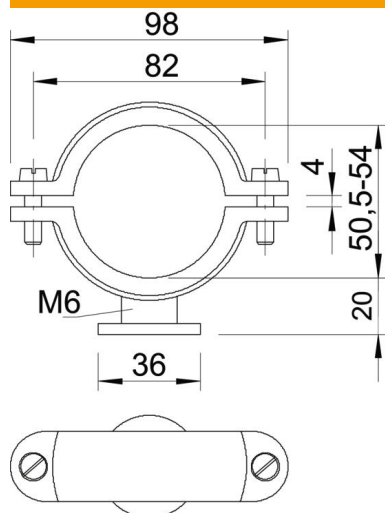

Dimension A	98 mm
Dimension B	82 mm
Dimension d	36 mm
Dimension H	20 mm
Dimension x	4 mm

Technical data

Number of cables/pipes	1
Version for	Closed
Fastening type	Screw hole
Suitable in fire protection area	no
Thread	M6
Size	Pg 9
Halogen-free	yes
Plastic-covered	no
Bolt	M6 x 20
Clamping range D, max.	54 mm
Clamping range D, min.	50.5 mm
UV-resistant	no