

Technical data sheet

Profile earthing rod connection with strip steel lug

Item number: 5003288



- With 2 m strip steel section FL 30 x 3.5
- With 2 through holes Ø 11 mm
- For the construction of earthing systems, e.g. antenna or earthing of building site distribution boards

St Steel

FT Hot-dip galvanised

Master data

Item number	5003288
Type	213 2000 M
Description 1	Cross profiled earth rod
Description 2	with steel strip lug
Manufacturer	OBO
Dimension	2000mm
Material	Steel
Surface	Hot-dip galvanised
Surface standard	DIN EN ISO 1461
Smallest sales unit	1
Unit of quantity	Piece
Weight	651.6 kg
Weight unit	kg/100 pc.

Technical data sheet

Profile earthing rod connection with strip steel lug

Item number: 5003288



Dimensions

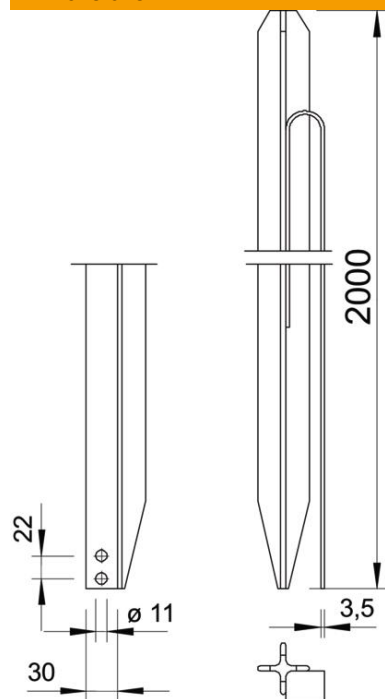

Length	2,000 mm
Dimension L	2,000 mm

Technical data

Version for	With strip steel lug
Profile type	Cross
Connection type	Miscellaneous