

# Technical data sheet

## Double trough, metal A2

Item number: 1196601



Metallic double trough as intermediate layer between two or three cables within a clamp clip.



**A2** Stainless steel

**2B** Bright, treated

### Master data

Item number	1196601
Type	2058 M2 34 A2
Description 1	Double trough
Manufacturer	OBO
Dimension	28-34mm
Material	Stainless steel
Surface	Bright, treated
Surface standard	
Smallest sales unit	50
Unit of quantity	Piece
Weight	3.76 kg
Weight unit	kg/100 pc.

# Technical data sheet

## Double trough, metal A2

Item number: 1196601



### Dimensions

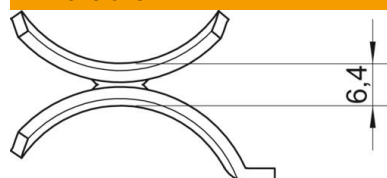

Dimension B	40 mm
Dimension H	6.4 mm
Dimension L	35 mm

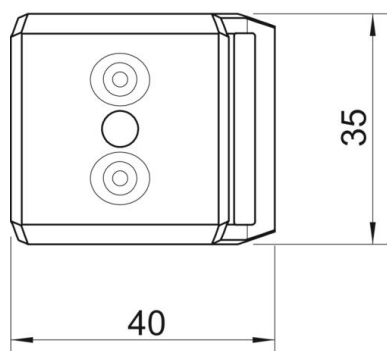

### Technical data

Counter-trough/clip version	Double trough
Suitable for max. cable diameter	34 mm
Clamping range D, max.	34 mm
Clamping range D, min.	28 mm