

Technical data sheet

Double trough, metal DD

Item number: 1199714



Metallic double trough as intermediate layer between two or three cables within a clamp clip.



St Steel

DD Strip galvanised zinc/aluminium, Double Dip

Master data

Item number	1199714
Type	2058 M2 16 DD
Description 1	Double trough
Manufacturer	OBO
Dimension	12-16mm
Material	Steel
Surface	Strip galvanised zinc/aluminium, Double Dip
Surface standard	DIN EN 10346
Smallest sales unit	50
Unit of quantity	Piece
Weight	1.8 kg
Weight unit	kg/100 pc.

Technical data sheet

Double trough, metal DD

Item number: 1199714



Dimensions

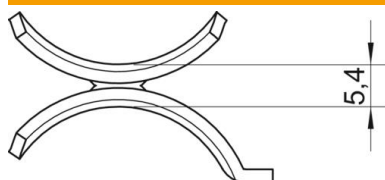

Dimension B	21.5 mm
Dimension H	5.4 mm
Dimension L	35 mm

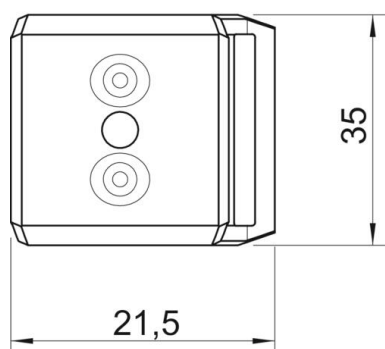

Technical data

Counter-trough/clip version	Double trough
Suitable for max. cable diameter	16 mm
Clamping range D, max.	16 mm
Clamping range D, min.	12 mm