

Technical data sheet

Universal counter-trough, plastic

Item number: 1198046



Regardless of the type of rail, the counter-trough can be used by applying it onto one side of the clamp clip. Due to an intelligent contour on the backside, the counter-trough can be combined to a double trough. Retrofitting possible without the need to dismantle.



PP Polypropylene

Master data

Item number	1198046
Type	2058UW 46 LGR
Description 1	Counter-trough
Description 2	combinable with double trough
Available from	15.05.2019
Manufacturer	OBO
Dimension	40-46mm
Colour	Light grey; RAL 7035
Material	Polypropylene
Smallest sales unit	50
Unit of quantity	Piece
Weight	0.647 kg
Weight unit	kg/100 pc.

Technical data sheet

Universal counter-trough, plastic

Item number: 1198046



Dimensions



Dimension B	51.5 mm
Dimension H	11.8 mm
Dimension L	40 mm

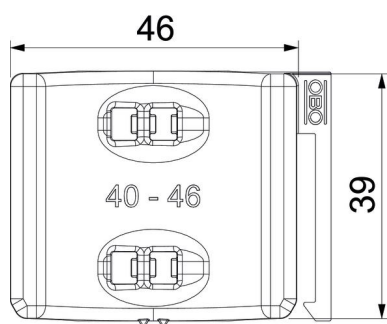

Technical data

Counter-trough/clip version	Counter sleeve
Suitable for max. cable diameter	46 mm
Clamping range D, max.	46 mm
Clamping range D, min.	40 mm