

Technical data sheet

Counter-trough, metal universal, DD

Item number: 1199935



Metal counter-trough, for mounting on clamp clip. Can be used universally, irrespective of the rail.



St Steel

DD Strip galvanised zinc/aluminium, Double Dip

Master data

Item number	1199935
Type	2058FW M 64 DD
Description 1	Counter-trough
Manufacturer	OBO
Dimension	58-64mm
Material	Steel
Surface	Strip galvanised zinc/aluminium, Double Dip
Surface standard	DIN EN 10346
Smallest sales unit	50
Unit of quantity	Piece
Weight	4.28 kg
Weight unit	kg/100 pc.

Technical data sheet

Counter-trough, metal universal, DD

Item number: 1199935



Dimensions



Dimension B	70 mm
Dimension H	22.4 mm
Dimension L	35 mm

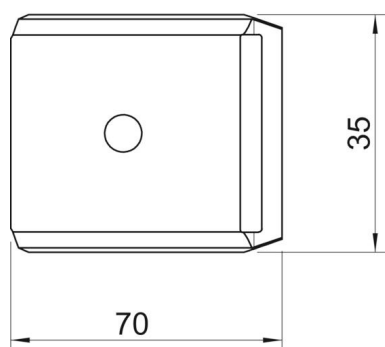

Technical data

Counter-trough/clip version	Counter sleeve
Suitable for max. cable diameter	64 mm
Halogen-free	yes
Clamping range D, max.	64 mm
Clamping range D, min.	58 mm