

Technical data sheet

ISO nail clip 2009, pure white

Item number: 2225727



ISO nail clip, short design.



PP Polypropylene

Master data

Item number	2225727
Type	2009 35 RW
Description 1	ISO nail clip
Manufacturer	OBO
Dimension	9mm, L35
Colour	Pure white; RAL 9010
Material	Polypropylene
Smallest sales unit	100
Unit of quantity	Piece
Weight	0.131 kg
Weight unit	kg/100 pc.

Technical data sheet

ISO nail clip 2009, pure white

Item number: 2225727



Dimensions

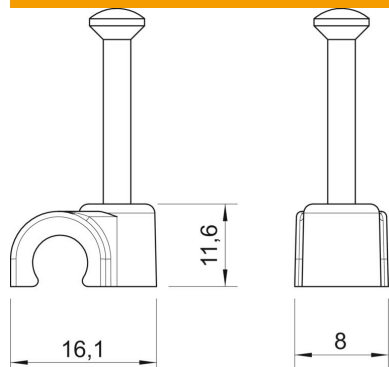

Dimension B	8 mm
Dimension H	11.6 mm
Dimension L	16.1 mm

Technical data

Double clip	no
Shape for cable diameter	Round (for round conductor)
For nail diameter	2,0x35
Hardened	yes
Halogen-free	yes
With nail	yes
Nail length	35 mm
Impact-resistant	no
Pipe locking	no