

Technical data sheet

Locknut, PG thread

Item number: 2091364



Locknuts, part M to DIN 46320 with Pg thread to DIN 40430. * Price according to DEL notation.



CuZn
37 Brass

N Nickel-plated

Master data

Item number	2091364
Type	169 MS PG36
Description 1	Locknut
Manufacturer	OBO
Dimension	PG36
Material	Brass
Surface	Nickel-plated
Surface standard	
Smallest sales unit	50
Unit of quantity	Piece
Weight	2.1 kg
Weight unit	kg/100 pc.

Technical data sheet

Locknut, PG thread

Item number: 2091364



Dimensions

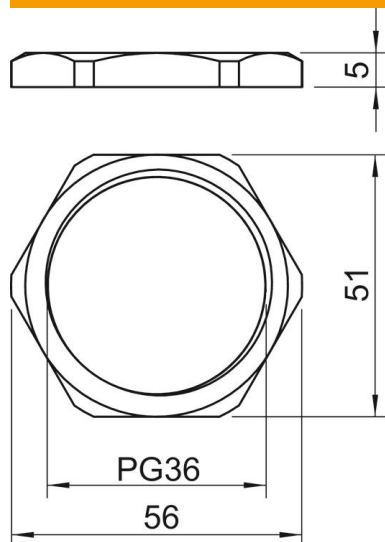

Dimension E	56 mm
Dimension L	5 mm

Technical data

Thread	Pg_36
Thread type	PG
Nominal thread size metric/PG	36
Fibre-glass reinforced	no
Halogen-free	no
Impact-resistant	no
WAF	51