

# Technical data sheet

## Locknut, metric thread with cutting teeth

Item number: 2091717



Locknuts DIN 46319 with metric thread IEC 423.

\* Prices according to DEL notation.



**CuZn**  
37 Brass

**N** Nickel-plated

### Master data

Item number	2091717
Type	169 MSS M25
Description 1	Locknut
Description 2	with cutting teeth
Manufacturer	OBO
Dimension	M25x1,5
Material	Brass
Surface	Nickel-plated
Surface standard	
Smallest sales unit	50
Unit of quantity	Piece
Weight	1.19 kg
Weight unit	kg/100 pc.

# Technical data sheet

Locknut, metric thread with cutting teeth

Item number: 2091717



## Dimensions

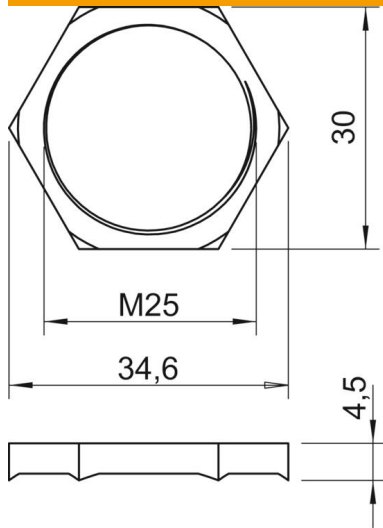

Dimension E	34.6 mm
Dimension L	4.5 mm

## Technical data

Thread	M25_x_1,5
Thread type	Metric
Nominal thread size metric/PG	25
Fibre-glass reinforced	no
Halogen-free	no
Impact-resistant	no
WAF	30